

●詳しくは、IP-Digaport X の取扱説明書をご覧ください。

6キー電話機N (数字表示付)

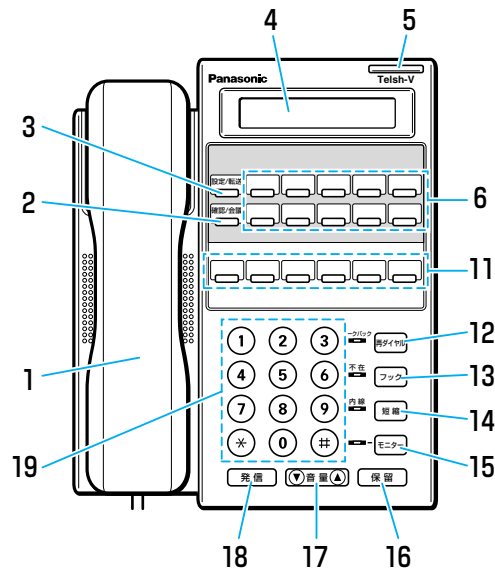

12キー電話機D (カナ表示付)

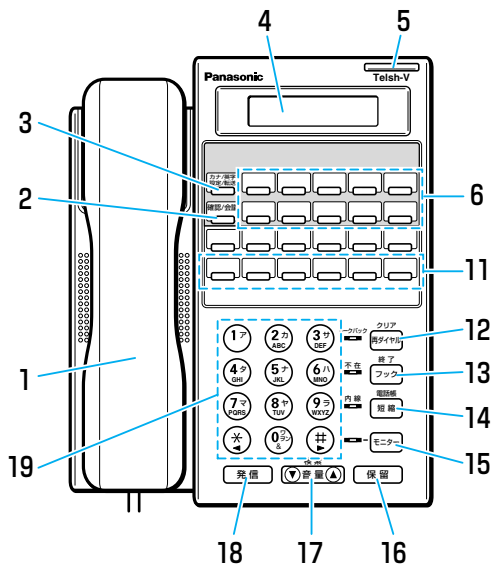

12キー電話機L (大形表示付)

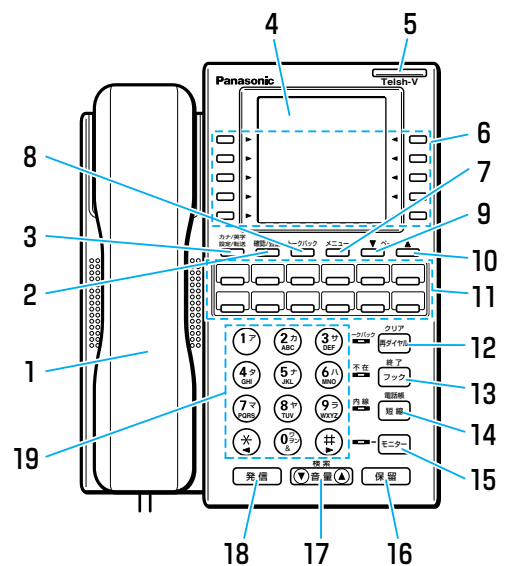























- | | | | | |
|---------------|--------------------|----------------------|------------------|-------------|
| 1 受話器 | 2 確認/会議 ボタン | 3 カナ/英字
設定/転送 ボタン | 4 表示部 | 5 着信ランプ |
| 6 ワンタッチボタン | 7 メニュー ボタン | 8 トークバック ボタン | 9 ▼ページ ボタン | 10 ▲ページ ボタン |
| 11 FF(外線) ボタン | 12 クリア
ダイヤル ボタン | 13 終了
フック ボタン | 14 電話帳
短縮 ボタン | 15 モニター ボタン |
| 16 保留 ボタン | 17 (▼)音量(▲) ボタン | 18 発信 ボタン | 19 電話番号ボタン | |



※ トークバック、メニュー、▼ページ、▲ページ ボタンは、大形表示付電話機にのみあります。

外線









各電話機共通

電話をかける	受話器を取って	 → 発信 → 電話番号
	受話器を取らずに	発信 → 電話番号 → 相手応答後 
	電話番号を確認してから (プリセットダイヤル)	電話番号 → 発信 → 
電話を受ける	通常	呼出音(着信ランプ点滅) →  → 外線
	着信自動応答 設定時	呼出音(着信ランプ点滅) → 
同じ相手にかけ直す(再ダイヤル)		クリア ダイヤル → 検索 音量 → かけたい電話番号を選ぶ → 発信 →  <ul style="list-style-type: none"> ● 数字表示付電話機では、電話番号の検索はできません。
かかってきた相手にかけ直す (コールバック)	着信通話履歴を使う	クリア ダイヤル 2回押す → 検索 音量 → かけたい電話番号を選ぶ → 発信 →  <ul style="list-style-type: none"> ● 数字表示付電話機では、この機能は使えません。
	着信不応答履歴を使う	クリア ダイヤル 3回押す → 検索 音量 → かけたい電話番号を選ぶ → 発信 →  <ul style="list-style-type: none"> ● 数字表示付電話機では、この機能は使えません。
短縮ダイヤル	個人短縮に記憶	モニター → カナ/英字 設定/転送 → 電話帳 短縮 → 短縮番号 800~999 → 電話番号(最大24ケタ) → 保留 → モニター
	個人短縮でかける	 または モニター → ワンタッチボタン (または 電話帳 短縮 → 短縮番号 800~999)
	共通短縮でかける	 または モニター → 発信 → 電話帳 短縮 → 短縮番号 000~799 または 0000~7999
	外線電話帳で 名前を検索してかける	電話帳 短縮 外線電話帳: 3回押す → 相手の名前は1文字入力 → 検索 音量 → かけたい相手の名前を選ぶ →  <ul style="list-style-type: none"> ● 短縮 を押す回数は、設定によって変更することができます。 ● 数字表示付電話機では、この機能は使えません。
保留	システム保留	<通話中>  → 保留 →  → 通話に 戻るとき  → 保留 していた 外線
	自己保留 設定時	<通話中>  → 通話中の 外線 →  → 通話に 戻るとき  → 保留 していた 外線
転送	近くの人に	<通話中>  → 保留 →  → 口頭 連絡 → [受ける人が  → 外線] 保留されている
	遠くの人に	<通話中>  → 保留 → 転送したい人の 内線番号 → 内線通話 → カナ/英字 設定/転送 →  <ul style="list-style-type: none"> ● 設定により、内線通話の後、受話器を戻すだけで転送できます。



外線 各電話機共通

転送	特定のグループに	<p>〈通話中〉 → 保留 → 井 → 呼出番号 0~9 → 音声で呼び出す →</p> <p>[受ける人が  → 井 → 井] → 内線通話 → カナ/英字設定/転送 → </p> <p>● 設定により、内線通話のあと、受話器を戻すだけで転送できます。</p> <p style="text-align: center;">一斉・グループ呼出番号</p> <p>0 一斉呼出 1 第1グループ 2 第2グループ 3 第3グループ 4 第4グループ 5 第5グループ 6 第6グループ 7 第7グループ 8 第8グループ 9 第9グループ (構内放送は、取付け時に設定)</p>
----	----------	--

内線 各電話機共通

電話番号を確認してかける (プリセットダイヤル)		内線番号 → 
個別呼出	信号音で	 または モニター → 内線番号
	音声で	 → 内線番号 → 1 → 呼びかける
	受ける	呼出音または音声(着信ランプ点滅) → 
保留		<p>〈通話中〉</p> <p> → 保留 →  → 通話に戻るとき  → 保留</p>
転送	近くの人に	<p>〈通話中〉</p> <p> → 保留 →  → 口頭連絡 → [受ける人が  → * → 6]</p>
	遠くの人に	<p>〈通話中〉</p> <p> → 保留 → 転送したい人の内線番号 → 内線通話 → カナ/英字設定/転送 → </p>
一斉・グループ呼出設定時	呼び出す	<p> → 井 → グループ番号 0~9 → 音声で呼び出す</p> <p style="text-align: center;">一斉・グループ呼出番号</p> <p>0 一斉呼出 1 第1グループ 2 第2グループ 3 第3グループ 4 第4グループ 5 第5グループ 6 第6グループ 7 第7グループ 8 第8グループ 9 第9グループ (構内放送は、取付け時に設定)</p>
	受ける	音声 →  → 井 → 井
トークバック設定/解除		<p>モニター → カナ/英字設定/転送 → 9 → 3</p> <p>● 大形表示付電話機では トークバック ボタンでも設定/解除できます。</p>

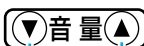
音量の調節 (各電話機共通)

 **音量**  で調節 (5段階)
 大きくするときに押す
 小さくするときに押す

- 受話音量.....通話中に押す
(通話後、受話器を戻すと元の音量に戻る)
- モニター(スピーカー)音量..... スピーカー音が聞こえているときに押す

ワンタッチボタンと個人短縮の関係 (カナ表示、数字表示付電話機)

※ 下記の表示部に表示される書体および文字サイズは実際とは異なります。

個人短縮でかける	共通短縮でかける	内線を個別に呼び出す	同じ相手にかかけ直す																																																																																																																																																																																																																																																								
<p>① 押す</p> <table border="1"> <tr><td><input type="checkbox"/></td><td>コジ ンタンシユクダ イヤル</td><td><input type="checkbox"/></td></tr> <tr><td><input type="checkbox"/></td><td>ガ イセンデ ンワチョウ</td><td><input type="checkbox"/></td></tr> <tr><td><input type="checkbox"/></td><td>ナイセンデ ンワチョウ</td><td><input type="checkbox"/></td></tr> <tr><td><input type="checkbox"/></td><td>システムキノウ</td><td><input type="checkbox"/></td></tr> <tr><td><input type="checkbox"/></td><td>デ ンワキバ ツキノウ</td><td><input type="checkbox"/></td></tr> </table> <p>② 「コジタンシユクダイヤル」の行を押す</p> <table border="1"> <tr><td></td><td>コジ ンタンシユクダ イヤル</td><td></td></tr> <tr><td><input type="checkbox"/></td><td>ガ イセンデ ンワチョウ</td><td><input type="checkbox"/></td></tr> <tr><td><input type="checkbox"/></td><td>ナイセンデ ンワチョウ</td><td><input type="checkbox"/></td></tr> <tr><td><input type="checkbox"/></td><td>システムキノウ</td><td><input type="checkbox"/></td></tr> <tr><td><input type="checkbox"/></td><td>デ ンワキバ ツキノウ</td><td><input type="checkbox"/></td></tr> </table> <p>③ かけたい名前(番号)の左または右を押す</p> <table border="1"> <tr><td><input type="checkbox"/></td><td>コジ ン 80</td><td>コジ ン 85</td><td><input type="checkbox"/></td></tr> <tr><td></td><td>コジ ン 81</td><td>コジ ン 86</td><td></td></tr> <tr><td><input type="checkbox"/></td><td>コジ ン 82</td><td>コジ ン 87</td><td><input type="checkbox"/></td></tr> <tr><td><input type="checkbox"/></td><td>コジ ン 83</td><td>コジ ン 88</td><td><input type="checkbox"/></td></tr> <tr><td><input type="checkbox"/></td><td>コジ ン 84</td><td>コジ ン 89</td><td><input type="checkbox"/></td></tr> </table> <ul style="list-style-type: none"> 短縮 80 ~ 89 を表示 短縮 90 ~ 99 は を押す <p>④ </p>	<input type="checkbox"/>	コジ ンタンシユクダ イヤル	<input type="checkbox"/>	<input type="checkbox"/>	ガ イセンデ ンワチョウ	<input type="checkbox"/>	<input type="checkbox"/>	ナイセンデ ンワチョウ	<input type="checkbox"/>	<input type="checkbox"/>	システムキノウ	<input type="checkbox"/>	<input type="checkbox"/>	デ ンワキバ ツキノウ	<input type="checkbox"/>		コジ ンタンシユクダ イヤル		<input type="checkbox"/>	ガ イセンデ ンワチョウ	<input type="checkbox"/>	<input type="checkbox"/>	ナイセンデ ンワチョウ	<input type="checkbox"/>	<input type="checkbox"/>	システムキノウ	<input type="checkbox"/>	<input type="checkbox"/>	デ ンワキバ ツキノウ	<input type="checkbox"/>	<input type="checkbox"/>	コジ ン 80	コジ ン 85	<input type="checkbox"/>		コジ ン 81	コジ ン 86		<input type="checkbox"/>	コジ ン 82	コジ ン 87	<input type="checkbox"/>	<input type="checkbox"/>	コジ ン 83	コジ ン 88	<input type="checkbox"/>	<input type="checkbox"/>	コジ ン 84	コジ ン 89	<input type="checkbox"/>	<p>① 押す</p> <table border="1"> <tr><td><input type="checkbox"/></td><td>コジ ンタンシユクダ イヤル</td><td><input type="checkbox"/></td></tr> <tr><td><input type="checkbox"/></td><td>ガ イセンデ ンワチョウ</td><td><input type="checkbox"/></td></tr> <tr><td><input type="checkbox"/></td><td>ナイセンデ ンワチョウ</td><td><input type="checkbox"/></td></tr> <tr><td><input type="checkbox"/></td><td>システムキノウ</td><td><input type="checkbox"/></td></tr> <tr><td><input type="checkbox"/></td><td>デ ンワキバ ツキノウ</td><td><input type="checkbox"/></td></tr> </table> <p>② 「ガイセンデンワチョウ」の行を押す</p> <table border="1"> <tr><td></td><td>コジ ンタンシユクダ イヤル</td><td><input type="checkbox"/></td></tr> <tr><td></td><td>ガ イセンデ ンワチョウ</td><td></td></tr> <tr><td><input type="checkbox"/></td><td>ナイセンデ ンワチョウ</td><td><input type="checkbox"/></td></tr> <tr><td><input type="checkbox"/></td><td>システムキノウ</td><td><input type="checkbox"/></td></tr> <tr><td><input type="checkbox"/></td><td>デ ンワキバ ツキノウ</td><td><input type="checkbox"/></td></tr> </table> <p>③ かけたい名前(番号)の左または右を押す (例: マツシタツウシンにかかけたいとき)</p> <table border="1"> <tr><td><input type="checkbox"/></td><td>アーオ</td><td>ハーホ</td><td><input type="checkbox"/></td></tr> <tr><td><input type="checkbox"/></td><td>カーコ</td><td>マーモ</td><td></td></tr> <tr><td><input type="checkbox"/></td><td>サーソ</td><td>ヤーン</td><td><input type="checkbox"/></td></tr> <tr><td><input type="checkbox"/></td><td>タート</td><td></td><td><input type="checkbox"/></td></tr> <tr><td><input type="checkbox"/></td><td>ナーノ</td><td></td><td><input type="checkbox"/></td></tr> </table> <p>④ かけたい名前(番号)の左または右を押す</p> <table border="1"> <tr><td></td><td>0 4 5 9 3 2 1 2 3 1</td><td></td></tr> <tr><td></td><td>マツシタツウシン</td><td></td></tr> <tr><td><input type="checkbox"/></td><td>マツシタツウシン</td><td><input type="checkbox"/></td></tr> <tr><td><input type="checkbox"/></td><td>マツシタデ ンキ</td><td><input type="checkbox"/></td></tr> <tr><td><input type="checkbox"/></td><td>マツシタデ ンコウ</td><td><input type="checkbox"/></td></tr> <tr><td><input type="checkbox"/></td><td>マツシタデ ンシ</td><td><input type="checkbox"/></td></tr> <tr><td><input type="checkbox"/></td><td>マツシタデ ンソウ</td><td><input type="checkbox"/></td></tr> </table> <ul style="list-style-type: none"> 次の画面をみるときは を押す <p>⑤ </p>	<input type="checkbox"/>	コジ ンタンシユクダ イヤル	<input type="checkbox"/>	<input type="checkbox"/>	ガ イセンデ ンワチョウ	<input type="checkbox"/>	<input type="checkbox"/>	ナイセンデ ンワチョウ	<input type="checkbox"/>	<input type="checkbox"/>	システムキノウ	<input type="checkbox"/>	<input type="checkbox"/>	デ ンワキバ ツキノウ	<input type="checkbox"/>		コジ ンタンシユクダ イヤル	<input type="checkbox"/>		ガ イセンデ ンワチョウ		<input type="checkbox"/>	ナイセンデ ンワチョウ	<input type="checkbox"/>	<input type="checkbox"/>	システムキノウ	<input type="checkbox"/>	<input type="checkbox"/>	デ ンワキバ ツキノウ	<input type="checkbox"/>	<input type="checkbox"/>	アーオ	ハーホ	<input type="checkbox"/>	<input type="checkbox"/>	カーコ	マーモ		<input type="checkbox"/>	サーソ	ヤーン	<input type="checkbox"/>	<input type="checkbox"/>	タート		<input type="checkbox"/>	<input type="checkbox"/>	ナーノ		<input type="checkbox"/>		0 4 5 9 3 2 1 2 3 1			マツシタツウシン		<input type="checkbox"/>	マツシタツウシン	<input type="checkbox"/>	<input type="checkbox"/>	マツシタデ ンキ	<input type="checkbox"/>	<input type="checkbox"/>	マツシタデ ンコウ	<input type="checkbox"/>	<input type="checkbox"/>	マツシタデ ンシ	<input type="checkbox"/>	<input type="checkbox"/>	マツシタデ ンソウ	<input type="checkbox"/>	<p>① 押す</p> <table border="1"> <tr><td><input type="checkbox"/></td><td>コジ ンタンシユクダ イヤル</td><td><input type="checkbox"/></td></tr> <tr><td><input type="checkbox"/></td><td>ガ イセンデ ンワチョウ</td><td><input type="checkbox"/></td></tr> <tr><td><input type="checkbox"/></td><td>ナイセンデ ンワチョウ</td><td><input type="checkbox"/></td></tr> <tr><td><input type="checkbox"/></td><td>システムキノウ</td><td><input type="checkbox"/></td></tr> <tr><td><input type="checkbox"/></td><td>デ ンワキバ ツキノウ</td><td><input type="checkbox"/></td></tr> </table> <p>② 「ナイセンデンワチョウ」の行を押す</p> <table border="1"> <tr><td><input type="checkbox"/></td><td>コジ ンタンシユクダ イヤル</td><td><input type="checkbox"/></td></tr> <tr><td><input type="checkbox"/></td><td>ガ イセンデ ンワチョウ</td><td><input type="checkbox"/></td></tr> <tr><td></td><td>ナイセンデ ンワチョウ</td><td></td></tr> <tr><td><input type="checkbox"/></td><td>システムキノウ</td><td><input type="checkbox"/></td></tr> <tr><td><input type="checkbox"/></td><td>デ ンワキバ ツキノウ</td><td><input type="checkbox"/></td></tr> </table> <p>③ かけたい名前(番号)の左または右を押す (例: イノウエイチロウにかかけたいとき)</p> <table border="1"> <tr><td></td><td>アーオ</td><td>ハーホ</td><td><input type="checkbox"/></td></tr> <tr><td><input type="checkbox"/></td><td>カーコ</td><td>マーモ</td><td><input type="checkbox"/></td></tr> <tr><td><input type="checkbox"/></td><td>サーソ</td><td>ヤーン</td><td><input type="checkbox"/></td></tr> <tr><td><input type="checkbox"/></td><td>タート</td><td></td><td><input type="checkbox"/></td></tr> <tr><td><input type="checkbox"/></td><td>ナーノ</td><td></td><td><input type="checkbox"/></td></tr> </table> <p>④ かけたい名前(番号)の左または右を押す</p> <table border="1"> <tr><td></td><td>コール</td><td>イノウ</td><td>イチロウ</td><td></td></tr> <tr><td></td><td>. 100</td><td></td><td></td><td></td></tr> <tr><td><input type="checkbox"/></td><td>アオキ</td><td>タロウ</td><td>200</td><td><input type="checkbox"/></td></tr> <tr><td><input type="checkbox"/></td><td>アライ</td><td>ハナコ</td><td>421</td><td><input type="checkbox"/></td></tr> <tr><td><input type="checkbox"/></td><td>イトウ</td><td>ジロウ</td><td>350</td><td><input type="checkbox"/></td></tr> <tr><td><input type="checkbox"/></td><td>イトウ</td><td>ケイコ</td><td>175</td><td><input type="checkbox"/></td></tr> <tr><td></td><td>イノウ</td><td>エイチロウ</td><td>120</td><td></td></tr> </table> <ul style="list-style-type: none"> 続けて 1 を押すと音声で呼び出せます。 次の画面をみるときは を押す <p>⑤ </p>	<input type="checkbox"/>	コジ ンタンシユクダ イヤル	<input type="checkbox"/>	<input type="checkbox"/>	ガ イセンデ ンワチョウ	<input type="checkbox"/>	<input type="checkbox"/>	ナイセンデ ンワチョウ	<input type="checkbox"/>	<input type="checkbox"/>	システムキノウ	<input type="checkbox"/>	<input type="checkbox"/>	デ ンワキバ ツキノウ	<input type="checkbox"/>	<input type="checkbox"/>	コジ ンタンシユクダ イヤル	<input type="checkbox"/>	<input type="checkbox"/>	ガ イセンデ ンワチョウ	<input type="checkbox"/>		ナイセンデ ンワチョウ		<input type="checkbox"/>	システムキノウ	<input type="checkbox"/>	<input type="checkbox"/>	デ ンワキバ ツキノウ	<input type="checkbox"/>		アーオ	ハーホ	<input type="checkbox"/>	<input type="checkbox"/>	カーコ	マーモ	<input type="checkbox"/>	<input type="checkbox"/>	サーソ	ヤーン	<input type="checkbox"/>	<input type="checkbox"/>	タート		<input type="checkbox"/>	<input type="checkbox"/>	ナーノ		<input type="checkbox"/>		コール	イノウ	イチロウ			. 100				<input type="checkbox"/>	アオキ	タロウ	200	<input type="checkbox"/>	<input type="checkbox"/>	アライ	ハナコ	421	<input type="checkbox"/>	<input type="checkbox"/>	イトウ	ジロウ	350	<input type="checkbox"/>	<input type="checkbox"/>	イトウ	ケイコ	175	<input type="checkbox"/>		イノウ	エイチロウ	120		<p>① 押す</p> <table border="1"> <tr><td><input type="checkbox"/></td><td>コジ ンタンシユクダ イヤル</td><td><input type="checkbox"/></td></tr> <tr><td><input type="checkbox"/></td><td>ガ イセンデ ンワチョウ</td><td><input type="checkbox"/></td></tr> <tr><td><input type="checkbox"/></td><td>ナイセンデ ンワチョウ</td><td><input type="checkbox"/></td></tr> <tr><td><input type="checkbox"/></td><td>システムキノウ</td><td><input type="checkbox"/></td></tr> <tr><td><input type="checkbox"/></td><td>デ ンワキバ ツキノウ</td><td><input type="checkbox"/></td></tr> </table> <p>② 押す</p> <p>③ 使いたい機能のワンタッチボタンを押す</p> <table border="1"> <tr><td></td><td>ハッシン リレキ</td><td></td></tr> <tr><td></td><td>チャクシンツウワ リレキ</td><td></td></tr> <tr><td></td><td>チャクシンフアウトウ リレキ</td><td></td></tr> <tr><td><input type="checkbox"/></td><td></td><td><input type="checkbox"/></td></tr> </table> <ul style="list-style-type: none"> 再ダイヤルでかけ直す 「ハッシン リレキ」の行を押す コールバック・着信通話履歴でかけ直す 「チャクシンツウワ リレキ」の行を押す コールバック・着信不応答履歴でかけ直す 「チャクシンフアウトウ リレキ」の行を押す <p>④ かけたい相手(電話番号または名前)のワンタッチボタンを押す (例: マツシタツウシンにかかけたいとき)</p> <table border="1"> <tr><td></td><td>マツシタツウシン</td><td></td></tr> <tr><td><input type="checkbox"/></td><td>0 3 1 2 2 3 4 5 6 7 8</td><td><input type="checkbox"/></td></tr> <tr><td><input type="checkbox"/></td><td>0 4 5 9 3 4 2 1 2 3 1</td><td><input type="checkbox"/></td></tr> <tr><td><input type="checkbox"/></td><td>0 3 9 8 7 6 5 4 3 2</td><td><input type="checkbox"/></td></tr> <tr><td><input type="checkbox"/></td><td>0 0 4 5 1 2 3 4 5 6 7</td><td><input type="checkbox"/></td></tr> </table> <p>⑤ </p>	<input type="checkbox"/>	コジ ンタンシユクダ イヤル	<input type="checkbox"/>	<input type="checkbox"/>	ガ イセンデ ンワチョウ	<input type="checkbox"/>	<input type="checkbox"/>	ナイセンデ ンワチョウ	<input type="checkbox"/>	<input type="checkbox"/>	システムキノウ	<input type="checkbox"/>	<input type="checkbox"/>	デ ンワキバ ツキノウ	<input type="checkbox"/>		ハッシン リレキ			チャクシンツウワ リレキ			チャクシンフアウトウ リレキ		<input type="checkbox"/>		<input type="checkbox"/>		マツシタツウシン		<input type="checkbox"/>	0 3 1 2 2 3 4 5 6 7 8	<input type="checkbox"/>	<input type="checkbox"/>	0 4 5 9 3 4 2 1 2 3 1	<input type="checkbox"/>	<input type="checkbox"/>	0 3 9 8 7 6 5 4 3 2	<input type="checkbox"/>	<input type="checkbox"/>	0 0 4 5 1 2 3 4 5 6 7	<input type="checkbox"/>
<input type="checkbox"/>	コジ ンタンシユクダ イヤル	<input type="checkbox"/>																																																																																																																																																																																																																																																									
<input type="checkbox"/>	ガ イセンデ ンワチョウ	<input type="checkbox"/>																																																																																																																																																																																																																																																									
<input type="checkbox"/>	ナイセンデ ンワチョウ	<input type="checkbox"/>																																																																																																																																																																																																																																																									
<input type="checkbox"/>	システムキノウ	<input type="checkbox"/>																																																																																																																																																																																																																																																									
<input type="checkbox"/>	デ ンワキバ ツキノウ	<input type="checkbox"/>																																																																																																																																																																																																																																																									
	コジ ンタンシユクダ イヤル																																																																																																																																																																																																																																																										
<input type="checkbox"/>	ガ イセンデ ンワチョウ	<input type="checkbox"/>																																																																																																																																																																																																																																																									
<input type="checkbox"/>	ナイセンデ ンワチョウ	<input type="checkbox"/>																																																																																																																																																																																																																																																									
<input type="checkbox"/>	システムキノウ	<input type="checkbox"/>																																																																																																																																																																																																																																																									
<input type="checkbox"/>	デ ンワキバ ツキノウ	<input type="checkbox"/>																																																																																																																																																																																																																																																									
<input type="checkbox"/>	コジ ン 80	コジ ン 85	<input type="checkbox"/>																																																																																																																																																																																																																																																								
	コジ ン 81	コジ ン 86																																																																																																																																																																																																																																																									
<input type="checkbox"/>	コジ ン 82	コジ ン 87	<input type="checkbox"/>																																																																																																																																																																																																																																																								
<input type="checkbox"/>	コジ ン 83	コジ ン 88	<input type="checkbox"/>																																																																																																																																																																																																																																																								
<input type="checkbox"/>	コジ ン 84	コジ ン 89	<input type="checkbox"/>																																																																																																																																																																																																																																																								
<input type="checkbox"/>	コジ ンタンシユクダ イヤル	<input type="checkbox"/>																																																																																																																																																																																																																																																									
<input type="checkbox"/>	ガ イセンデ ンワチョウ	<input type="checkbox"/>																																																																																																																																																																																																																																																									
<input type="checkbox"/>	ナイセンデ ンワチョウ	<input type="checkbox"/>																																																																																																																																																																																																																																																									
<input type="checkbox"/>	システムキノウ	<input type="checkbox"/>																																																																																																																																																																																																																																																									
<input type="checkbox"/>	デ ンワキバ ツキノウ	<input type="checkbox"/>																																																																																																																																																																																																																																																									
	コジ ンタンシユクダ イヤル	<input type="checkbox"/>																																																																																																																																																																																																																																																									
	ガ イセンデ ンワチョウ																																																																																																																																																																																																																																																										
<input type="checkbox"/>	ナイセンデ ンワチョウ	<input type="checkbox"/>																																																																																																																																																																																																																																																									
<input type="checkbox"/>	システムキノウ	<input type="checkbox"/>																																																																																																																																																																																																																																																									
<input type="checkbox"/>	デ ンワキバ ツキノウ	<input type="checkbox"/>																																																																																																																																																																																																																																																									
<input type="checkbox"/>	アーオ	ハーホ	<input type="checkbox"/>																																																																																																																																																																																																																																																								
<input type="checkbox"/>	カーコ	マーモ																																																																																																																																																																																																																																																									
<input type="checkbox"/>	サーソ	ヤーン	<input type="checkbox"/>																																																																																																																																																																																																																																																								
<input type="checkbox"/>	タート		<input type="checkbox"/>																																																																																																																																																																																																																																																								
<input type="checkbox"/>	ナーノ		<input type="checkbox"/>																																																																																																																																																																																																																																																								
	0 4 5 9 3 2 1 2 3 1																																																																																																																																																																																																																																																										
	マツシタツウシン																																																																																																																																																																																																																																																										
<input type="checkbox"/>	マツシタツウシン	<input type="checkbox"/>																																																																																																																																																																																																																																																									
<input type="checkbox"/>	マツシタデ ンキ	<input type="checkbox"/>																																																																																																																																																																																																																																																									
<input type="checkbox"/>	マツシタデ ンコウ	<input type="checkbox"/>																																																																																																																																																																																																																																																									
<input type="checkbox"/>	マツシタデ ンシ	<input type="checkbox"/>																																																																																																																																																																																																																																																									
<input type="checkbox"/>	マツシタデ ンソウ	<input type="checkbox"/>																																																																																																																																																																																																																																																									
<input type="checkbox"/>	コジ ンタンシユクダ イヤル	<input type="checkbox"/>																																																																																																																																																																																																																																																									
<input type="checkbox"/>	ガ イセンデ ンワチョウ	<input type="checkbox"/>																																																																																																																																																																																																																																																									
<input type="checkbox"/>	ナイセンデ ンワチョウ	<input type="checkbox"/>																																																																																																																																																																																																																																																									
<input type="checkbox"/>	システムキノウ	<input type="checkbox"/>																																																																																																																																																																																																																																																									
<input type="checkbox"/>	デ ンワキバ ツキノウ	<input type="checkbox"/>																																																																																																																																																																																																																																																									
<input type="checkbox"/>	コジ ンタンシユクダ イヤル	<input type="checkbox"/>																																																																																																																																																																																																																																																									
<input type="checkbox"/>	ガ イセンデ ンワチョウ	<input type="checkbox"/>																																																																																																																																																																																																																																																									
	ナイセンデ ンワチョウ																																																																																																																																																																																																																																																										
<input type="checkbox"/>	システムキノウ	<input type="checkbox"/>																																																																																																																																																																																																																																																									
<input type="checkbox"/>	デ ンワキバ ツキノウ	<input type="checkbox"/>																																																																																																																																																																																																																																																									
	アーオ	ハーホ	<input type="checkbox"/>																																																																																																																																																																																																																																																								
<input type="checkbox"/>	カーコ	マーモ	<input type="checkbox"/>																																																																																																																																																																																																																																																								
<input type="checkbox"/>	サーソ	ヤーン	<input type="checkbox"/>																																																																																																																																																																																																																																																								
<input type="checkbox"/>	タート		<input type="checkbox"/>																																																																																																																																																																																																																																																								
<input type="checkbox"/>	ナーノ		<input type="checkbox"/>																																																																																																																																																																																																																																																								
	コール	イノウ	イチロウ																																																																																																																																																																																																																																																								
	. 100																																																																																																																																																																																																																																																										
<input type="checkbox"/>	アオキ	タロウ	200	<input type="checkbox"/>																																																																																																																																																																																																																																																							
<input type="checkbox"/>	アライ	ハナコ	421	<input type="checkbox"/>																																																																																																																																																																																																																																																							
<input type="checkbox"/>	イトウ	ジロウ	350	<input type="checkbox"/>																																																																																																																																																																																																																																																							
<input type="checkbox"/>	イトウ	ケイコ	175	<input type="checkbox"/>																																																																																																																																																																																																																																																							
	イノウ	エイチロウ	120																																																																																																																																																																																																																																																								
<input type="checkbox"/>	コジ ンタンシユクダ イヤル	<input type="checkbox"/>																																																																																																																																																																																																																																																									
<input type="checkbox"/>	ガ イセンデ ンワチョウ	<input type="checkbox"/>																																																																																																																																																																																																																																																									
<input type="checkbox"/>	ナイセンデ ンワチョウ	<input type="checkbox"/>																																																																																																																																																																																																																																																									
<input type="checkbox"/>	システムキノウ	<input type="checkbox"/>																																																																																																																																																																																																																																																									
<input type="checkbox"/>	デ ンワキバ ツキノウ	<input type="checkbox"/>																																																																																																																																																																																																																																																									
	ハッシン リレキ																																																																																																																																																																																																																																																										
	チャクシンツウワ リレキ																																																																																																																																																																																																																																																										
	チャクシンフアウトウ リレキ																																																																																																																																																																																																																																																										
<input type="checkbox"/>		<input type="checkbox"/>																																																																																																																																																																																																																																																									
	マツシタツウシン																																																																																																																																																																																																																																																										
<input type="checkbox"/>	0 3 1 2 2 3 4 5 6 7 8	<input type="checkbox"/>																																																																																																																																																																																																																																																									
<input type="checkbox"/>	0 4 5 9 3 4 2 1 2 3 1	<input type="checkbox"/>																																																																																																																																																																																																																																																									
<input type="checkbox"/>	0 3 9 8 7 6 5 4 3 2	<input type="checkbox"/>																																																																																																																																																																																																																																																									
<input type="checkbox"/>	0 0 4 5 1 2 3 4 5 6 7	<input type="checkbox"/>																																																																																																																																																																																																																																																									